

Shield 1500

Photochemical Water Purification System

Installation, Operation and Maintenance



Manufactured in the USA by:



2827 SE 75th Avenue, Hillsboro, OR 97123 USA
t. +1.503.616.2652 | e. support@puralytics.com
www.puralytics.com

Copyright © Puralytics – 2017
All rights reserved.



CONGRATULATIONS,

You have purchased a Puralytics Shield 1500 Photochemical Water Purification System. By purchasing this system, you have taken the first step in ensuring the safety of your water supply. Your Shield 1500 system uses advanced nanotechnology and is designed to provide you with years of trouble-free operation with minimal maintenance required.

Table of Contents

Symbols	4
Parts of the System.....	5
Parts of the System.....	6
Parts of the System.....	6
System Components.....	8
Accessory and Replacement Parts List	8
Safety Instructions	9
Facility Requirements.....	11
Chapter 1: System Overview	12
Chapter 2: Installing Your Shield 1500	14
Unpacking and System Inspection.....	14
System Setup	16
Water Connections	16
Electrical Connections.....	17
Pre-Startup Testing.....	17
Chapter 3: System Start-Up	17
Chapter 4: System Operation.....	18
Operating Procedures.....	18
Maintenance Items.....	18
Chapter 5: Cooling Fan Maintenance	19
Chapter 6: UVC Lamp Use and Maintenance.....	20
Chapter 7: 20-inch NanoMesh Cartridge Maintenance.....	24
Chapter 8: Other Maintenance	26

Symbols



Caution: This symbol indicates that you need to pay attention to a potential hazard to your personal safety or to the safe operation of the system.



Electrical Warning: This symbol indicates that a potential hazard to your personal safety exists from a voltage source within the system.



Fragile: This symbol indicates that there is glass in this assembly and special care needs to be taken to prevent breakage.



WEEE (Waste Electrical or Electronic Equipment): This symbol indicates that you should not discard wasted electrical or electronic equipment (WEEE) in the trash. For proper disposal, contact your local recycling/reuse or hazardous waste center.

All occurrences of "Shield 1500" within this document refer to the "Shield 1500" system.

Parts of the System

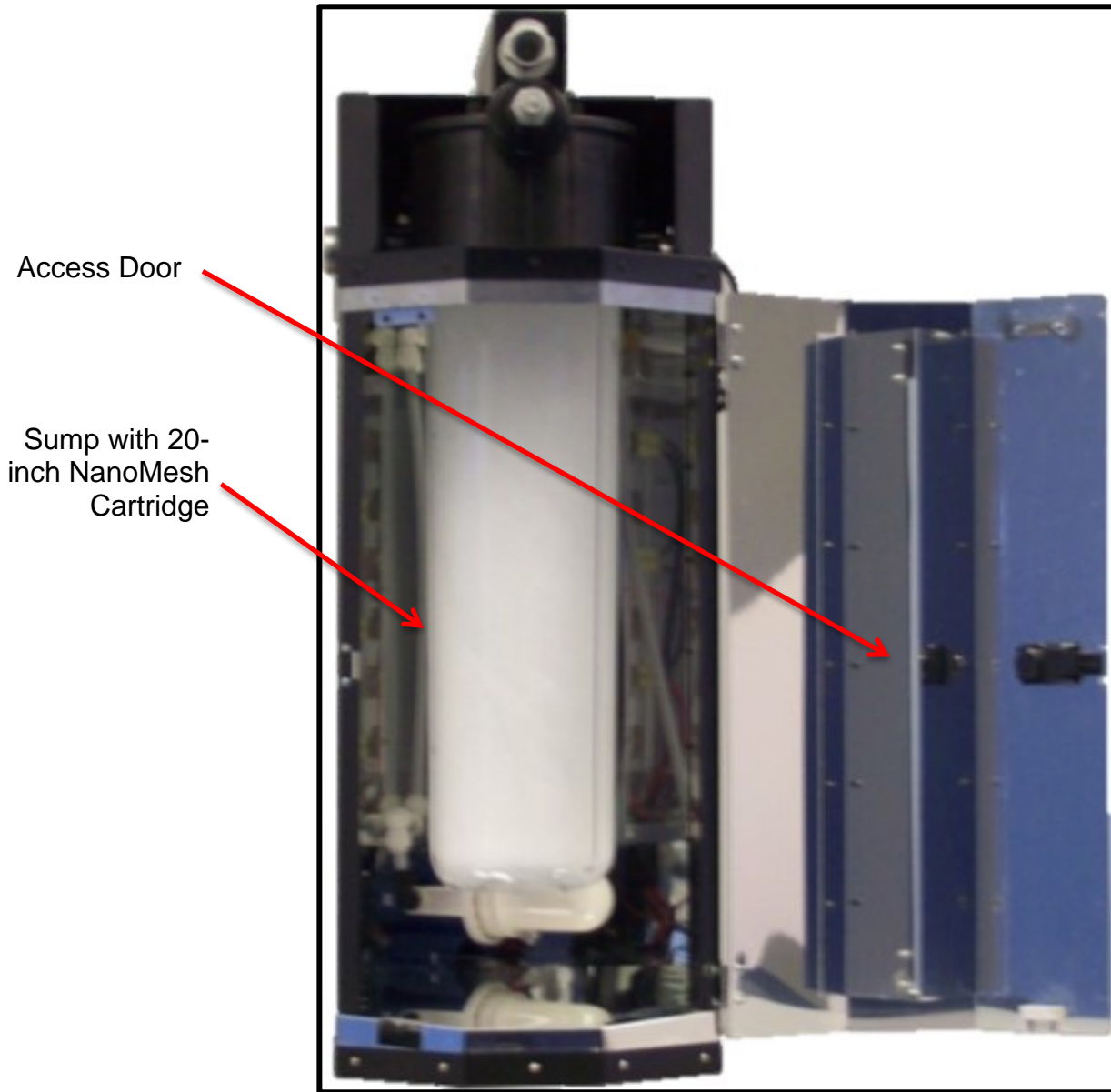

Figure 1. System with access door open

Parts of the System

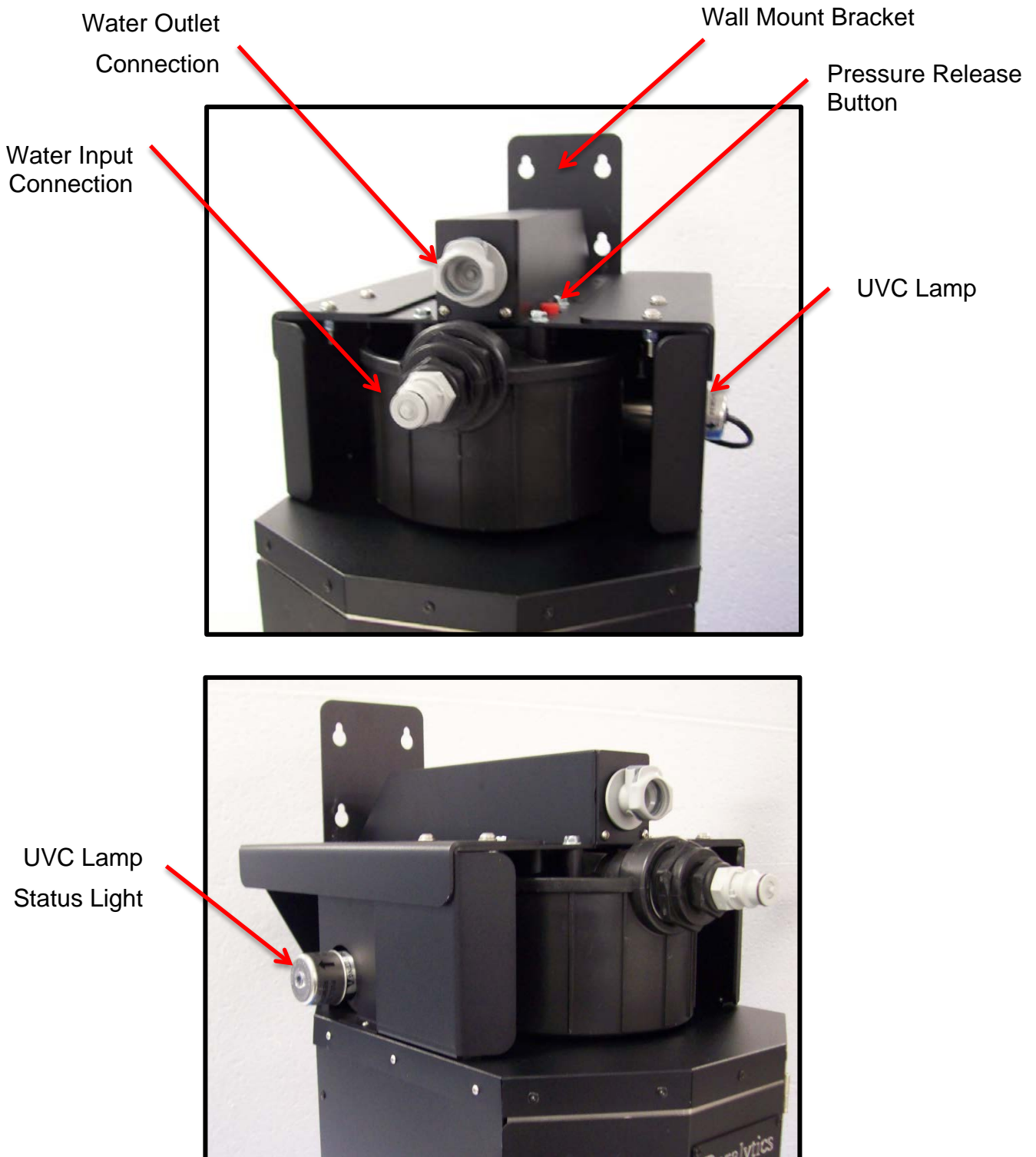
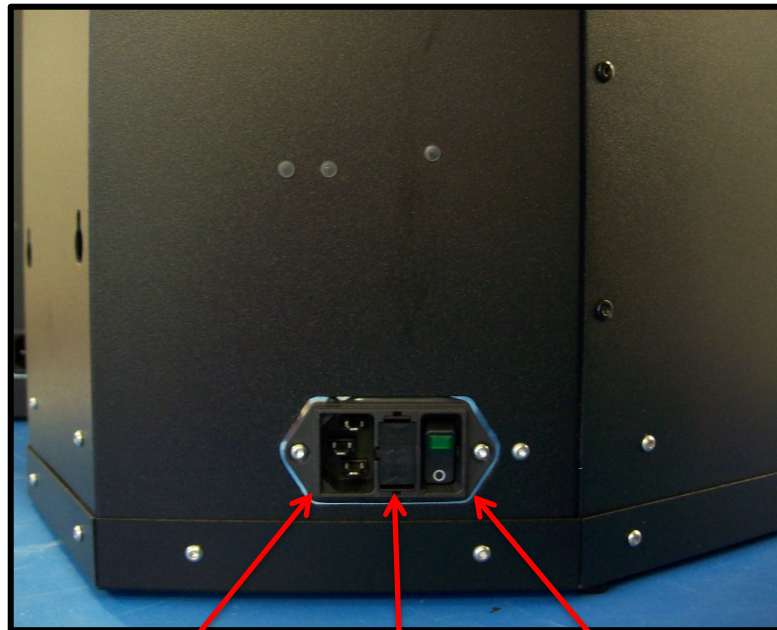

Figure 2. Top views of Shield 1500

Parts of the System



Power Receptacle

AC Fuse

Power Switch

Figure 3. Side view of Shield 1500 base

System Components

These components should arrive with the Shield system:

- Shield 1500
- Power Cord
- Water Input and Output hose fittings for 3/8" hose

Accessory and Replacement Parts List

Additionally, parts are available for purchase as accessories or replacements:

- Replacement 20-inch NanoMesh Cartridge
- Sump spanner wrench
- Replacement UVC Lamp
- Replacement Quartz Sleeve (includes two O-rings)
- AC Fuse (beyond the spare already included in the fuse holder; see Chapter 8)
- Adapting/additional hose/pipe fittings; hose/pipe

A Puralytics pretreatment system is required in most situations to provide filtration and ion exchange/softening. The pretreatment system is not addressed in this guide.

Safety Instructions

WARNING – to guard against injury, basic safety precautions should be observed, including the following:

1. READ AND FOLLOW ALL SAFETY INSTRUCTIONS.



2. **CAUTION** – Always disconnect power before servicing.



3. **CAUTION** – To avoid possible electrical shock, employ a three-wire electrical cable and plug to connect the equipment to EARTH GROUND. Ensure the wall outlet receptacle is properly wired and connected to EARTH GROUND. DO NOT use a three-to-two wire plug adapter. DO NOT use a two-wire extension cord or a two wire multiple-outlet power strip. DO NOT remove any panels – panels should be removed only by qualified service personnel. Never yank the cord to remove from an outlet; grasp the wall plug and pull to disconnect.



4. Always unplug the Shield 1500 system before performing any cleaning or maintenance activities, including opening the top access door on the unit for any purpose. Always assure the system has been completely reassembled, including closing the top access door, before re-connecting power cord to outlet.



5. Do not operate the Shield 1500 without a 5mmx20mm Slo-Blo or T-Lag fuse installed in the fuse folder. Fuse current ratings must be selected for compatibility with the operational input voltage and be within the range of 100-250 VAC RMS:

- For supply voltages in a 100-127 VAC range, a fuse rating of 10A is required (Littelfuse P/N 0477010.MXP or equiv.)
- For supply voltages in a 200-250 VAC range, a fuse rating of 5A is required (Littelfuse P/N 0477005.MXP or equiv.)
- For other supply voltages, contact Puralytics for acceptable fuse ratings.



6. **DANGER** – To avoid possible electric shock, special care should be taken since water is present near electrical equipment. Unless a situation is encountered that is explicitly addressed by the provided maintenance and troubleshooting sections, do not attempt repairs yourself – refer to an authorized service facility.



7. Do not operate the Shield 1500 system if it has a damaged power cord or plug, if it is malfunctioning, or if it has been dropped or damaged in any manner.



8. Do not use this water purification system for other than intended use (potable water applications). Use of attachments not recommended or sold by the manufacturer / distributor may cause an unsafe condition.



9. Intended for indoor use only. Do not install this water purification system where it will be exposed to the weather or to temperatures below freezing. Do not store this system where it will be exposed to the weather. Do not store this system where it will be exposed to freezing temperatures after it has been in service.



10. Read and observe all the important notices and warnings on the UVC disinfection system.



11. If an extension cord is necessary, a cord with a proper rating should be used. An extension cord, if used, must be rated for equal or higher power than the systems rating or it may overheat. Care should be taken to arrange the cord so that it will not be tripped over or pulled. Circuit breaker must not exceed the power cord current rating (e.g., 15A for North American NEMA 5-15P).



12. Some blue light will be visible outside the Shield 1500 during normal operation. **THIS BLUE LIGHT IS NORMAL (when water is flowing) AND DOES NOT POSE AN EYE HAZARD TO THE USER.**

SAVE THESE INSTRUCTIONS.

Facility Requirements

The Shield 1500 water treatment system is designed to kill pathogens and remove a wide range of organic contaminants present in the water as well as decrease the concentration of heavy metal contaminants. Shield 1500 Product details are as follows:

- Water Recovery: 100%
- Water Production: 1.3-3.9 L/min | 500–1500 gallons per day (gpd) Note that unit can be operated as low as 0.5 L/min (200 gpd) if there is no pre-treatment system.
- Pressure Drop: 2–7 psi @ 200-1500 gpd
- Power Consumption: 570 Watts
- Power Input: 100-240V 50Hz-60Hz
- Ambient Operating Temp: 5°C–40°C | 41°F–104°F
- Dim: 91 x 32 x 45 cm | 36H x 13W x 18D in
- Wet Weight: 30.5 kg | 67 lb
- Dry Weight: 24.5 kg | 54 lb

The Shield 1500 performance can vary over time based on the input water quality. Puralytics is actively assessing Shield 1500's sensitivity to a wide range of contaminants. Preliminary results of this study indicate that water to be treated by the Shield 1500 should be within the following levels to meet the performance targets and maintenance schedule when operating at 3.9 L/min (1500 gpd):

- pH: 6 - 10
- Temperature: 5°C - 35°C (41°F - 95°F)
- Iron¹: <0.6 mg/L
- Hardness: <0.05 mg/L equivalent of calcium carbonate
- Manganese¹: <0.05 mg/L
- Sulfate: <10ppm
- Phosphate: <10ppm
- Turbidity: <5 NTU
- Surfactants: <0.05 mg/L
- Total Chlorine: <2.0 mg/L
- BOD/TOC: <4 mg/L
- Dissolved Oxygen: >4 mg/L



If your water chemistry contains levels outside those mentioned above, proper pre-treatment is recommended to adjust the levels to within these limits. Contact the factory at +1.503.616.2652.

¹ Required for internal UVC disinfection system.

Chapter 1: System Overview

The Puralytics Shield 1500, shown in Figure 4 represents the state of the art in photochemical water purification.

Five independent photochemical processes act synergistically to remove organic chemicals, heavy metals, and microbiological contaminants from process water at flow rates up to 3.9 liters per minute (up to 1500 gallons per day).



Figure 4. Shield 1500



Electrical power is supplied to the unit through a grounded, 3-conductor male Power Input Module at the electrical end of the unit, as shown in Figure 5. The power cable supplied with the unit is rated for currents up to 15 A at 120 VAC (8 A at 220 VAC).



Figure 5. Power input module

Water enters the system through a water input port and exits through a water outlet port, both located on one end of the unit as shown in Figure 6. For proper operation, water must flow into the input port (bottom) and out of the output port (top).

 Reverse water flow through the system will result in reduced performance and reduced life of the system.

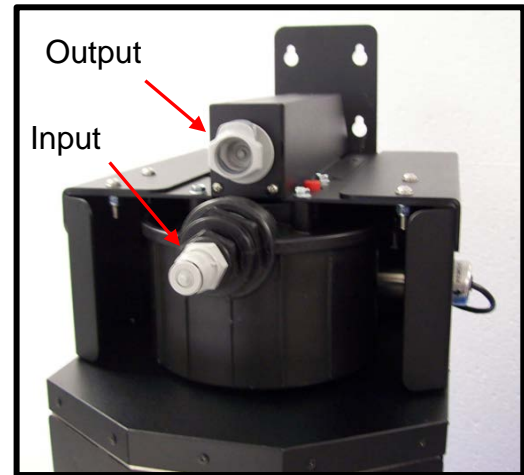

Figure 6. Water Ports

The Shield 1500 contains an Access Door, as shown in Figure 7, to allow the user to access the sump and its 20-inch NanoMesh Cartridge located within the compartment for maintenance – see *Chapter 7 for details*.

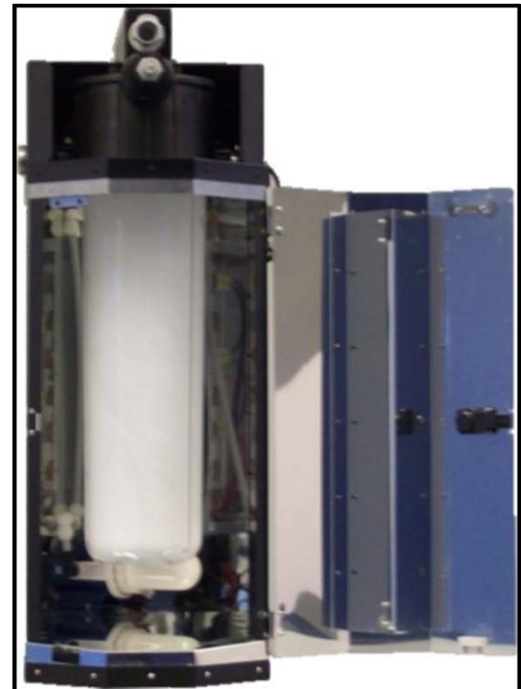

Figure 7. Access Door and Interior

Chapter 2: Installing Your Shield 1500

Unpacking and System Inspection

The Shield 1500 water treatment system is shipped in a protective box.

On receipt, inspect the box for damage indicating mishandling during shipment. If such damage is observed, photograph the box to document the damage before opening the box and contact the shipping carrier as soon as possible. Contact Puralytics to inform them of the damage during shipment.

To unpack the Shield 1500 from the box first remove all the protective foam packaging material. Then remove the Shield 1500 from the box and place it upright on a stable surface.

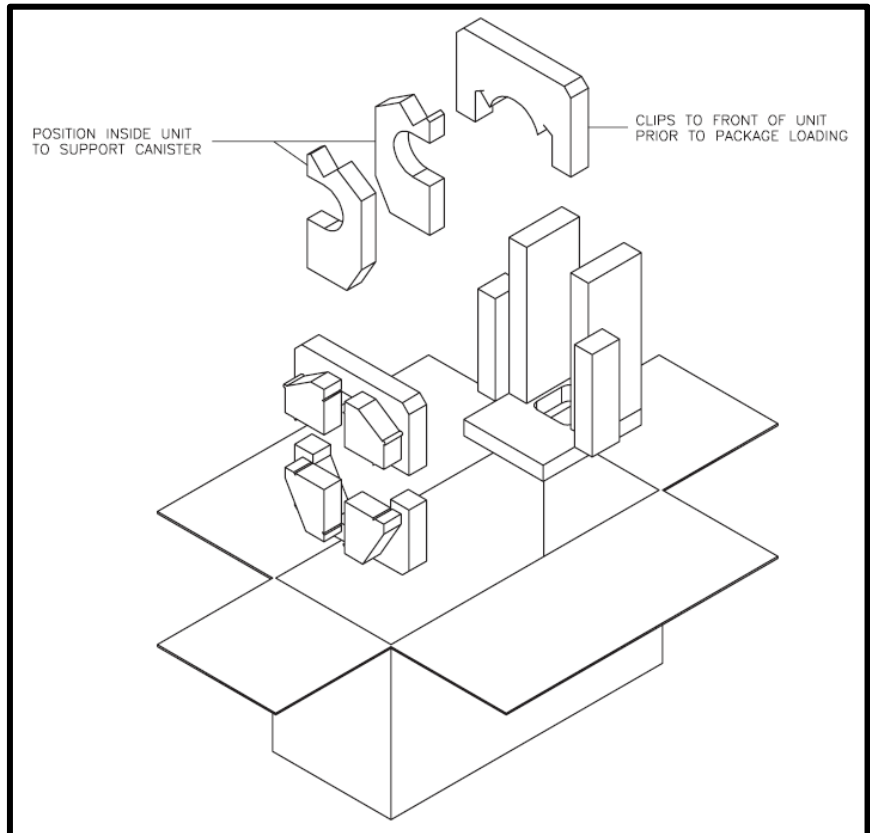



Figure 8. Shipping material

Inspect the Shield 1500 for signs of mechanical damage. If damage is observed, photograph the damage and contact Puralytics.

 Before turning on the Shield 1500, open the access door and remove the foam supporting the sump.

Inspect the contents of the accessories box. Compare the contents to the parts list located at the front of this document. If breakage of the contents is observed or parts are missing, photograph the damage or contents and contact Puralytics.

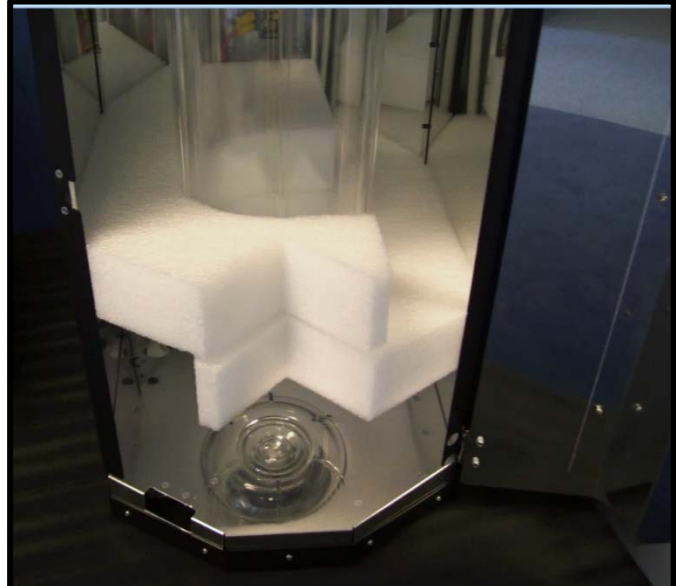

Figure 9. Remove foam inside Shield

SAVE THE BOX AND PROTECTIVE FOAM PACKAGING MATERIAL for possible future shipping, as necessary.

System Setup

Place the Shield 1500 on a stable surface or wall mount the system where it is to be installed. Hardware for wall mounting the Shield 1500 is not provided, but the holes at the top of the mounting bracket allow many hardware choices.



Water Connections

The water input and output connections are supplied with the Shield 1500. These connectors will accommodate a 3/8-inch hose. Adaption from a 3/8" hose to another hose or pipe type may be required.





Figure 10 – Colder Product Corporation (CPC) barbed fittings HFS 12 Series shown.



Electrical Connections

  The electrical power connector on the Shield 1500 is a standard 3-pin (IEC320-C14) male connector. A 3-conductor power cable with a mating female connector (IEC320-C13) is supplied with the system. The Shield 1500 is compatible with supplied electrical AC power at voltages within the range of 100-240VAC RMS and frequencies within the range of 50-60 Hz.



The fuse shipped in the fuse holder of the Shield 1500 is suitable for operation with supplied electrical AC power at voltages in the customer's anticipated range.

  Protective grounding of the Shield 1500 is required for safe operation. Ensure that the wall outlet receptacle is properly wired and earth grounded. **DO NOT** use a three-to-two wire plug adapter. **DO NOT** use a two-wire extension cord or a two-wire multiple-outlet power strip. Do not modify the supplied power cable in any manner that defeats this requirement for protective grounding of the Shield 1500.

Pre-Startup Testing

  Disconnect power from Shield 1500 and supply water to the input of the system at a pressure not to exceed 65 psi (4.48 bar, 448 kPa). Flush a minimum of 20 L of clean water through the system. Verify that no water leaks are observed at the input or output connectors, and that no water leaks from the body of the system.

Chapter 3: System Start-Up

  Before connecting power to the system, ensure that the power switch is in the OFF state ("O" side of rocker switch depressed). Connect a properly grounded 3-conductor cable from a properly grounded power outlet to the system power input. Switch the system to the ON state by depressing the green indicator side of the power rocker switch.

Chapter 4: System Operation

The Shield 1500 is designed to operate with a minimal amount of operating supervision or maintenance, providing the water quality meets input requirements are met (see **Facility Requirements** section).

Operating Procedures

1. Make sure the water fittings are connected to Shield 1500 as detailed under the “Water Connections” section above.
2. Connect electrical power to Shield 1500 as detailed under “Electrical Connections.”
3. Follow the instructions under “System Setup” to start Shield 1500 operation.
4. Start water flow at a rate of at least 1.3 L/min and not more than 3.9 L/min. Simultaneously depress the red air release button at the top of the unit until air stops coming out at the button.
5. Allow at least 15 minutes of discharging to waste to allow the UVC lamp to warm up. This should also be sufficient time to remove the worst air bubbles from the 20-inch NaonMesh Cartridge. If significant air bubbles are still present discharge to waste until most large air bubbles have been flushed from the system to ensure peak performance. Turning up the flow rate will facilitate air flushing.
6. Adjust water flow rate to the desired rate. Lower rates will facilitate slightly higher levels of treatment.

Maintenance Items

The following ordinary maintenance schedule when operating the Shield 1500 *continuously* would consist of:

- Cooling Fan check; UVC quartz sleeve cleaning
Recommended quarterly. *See Chapters 5 and 6 for details.*
- 20-inch NanoMesh replacement:
About annually.* *See Chapter 7 for details.*
- UVC lamp replacement:
About annually. *See Chapter 6 for details.*
- LED replacement:
About every 4 years.* *Contact Puralytics for replacement after this time has passed.*

*If not operated continuously these can all be maintained at a proportionately lower frequency.

Chapter 5: Cooling Fan Maintenance

Introduction

A cooling fan is provided on the underside of the unit to maintain optimal power supply to the LEDs by the LED power supplies. The fan operates whenever the unit power is on providing an auditory reminder that the unit (and UVC lamp) is powered. Air is pulled from the back/below, is blown over the power supplies and exits through a grid of holes on the bottom-center as well as slots on either side of the bottom.

Inspection

Always listen for the fan. Any changes of pitch could indicate obstruction of the fan inlet grille. Quarterly, access the bottom of the unit (if situated on a counter, just tip the unit backward slightly) and look for any lint or other obstruction of the fan inlet grille.

Maintenance

Anytime that there is material on the fan grille, remove it with a brush and/or compressed air.

Chapter 6: UVC Lamp Use and Maintenance

Introduction

The UVC Lamp is designed to operate with a minimal amount of maintenance, providing the water quality meets input requirements (see **Facility Requirements** section). The UVC Lamp provides a boost in microbial disinfection on top of that already provided by the 20-inch NanoMesh Cartridge.

Ordinary maintenance consists of;

- Cleaning or replacing the quartz sleeve.
- Lamp replacement – recommended every 10,000 hours of operation (approximately 60 weeks of continuous service independent of operational flow). More frequent replacement is recommended if the unit is turned on and off frequently.

Always disconnect the water supply and completely drain the system if it will be subjected to temperatures below the freezing point of water.

Inspection

1. Regularly inspect the UVC Lamp:

- An LED indicator light, located on the end opposite of the easy off end cap (depicted in Figure 14), provides visual indication of germicidal lamp operation and should be illuminated during the Shield 1500 operation. This indicator light does not, however, indicate the level of ultraviolet intensity or transmission through the water.
- Quarterly cleaning of the quartz sleeve is recommended for optimal light delivery.

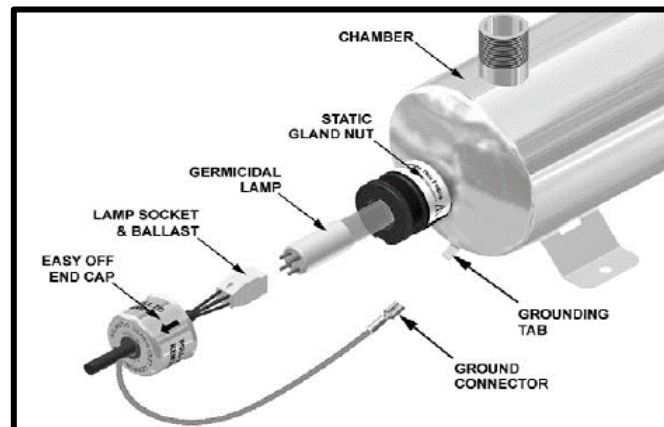

Figure 14. Schematic of the UVC lamp assembly

2. To ensure proper operation of the UVC Lamp, regular biological testing of the treated water should be performed on a schedule recommended by local public health authorities. At minimum test:



Shield 1500 Owner's Manual

- At installation,
- Quarterly after cleaning and
- After lamp replacement.

UVC LAMP REMOVAL OR REPLACEMENT

The Shield 1500 has been designed such that the UVC Lamp can be serviced without removing the sheet metal cover of the Shield 1500.

1. **Disconnect power to Shield 1500** and disconnect both the water input and output connections.
2. Remove easy-off end cap by pulling cap off static gland nut as shown in the top image of Figure 15.
3. Carefully withdraw lamp approximately 2 inches from chamber. While holding lamp end, remove lamp socket from exposed lamp end as shown in the middle image of Figure 15.
4. Carefully withdraw lamp from chamber. Be sure to withdraw lamp straight out without angling until completely clear of quartz sleeve as shown in the bottom image of Figure 15.

CAUTION: Lamp and quartz sleeve are easily damaged. Exercise care when handling.

5. Reinstall lamp in reverse order.

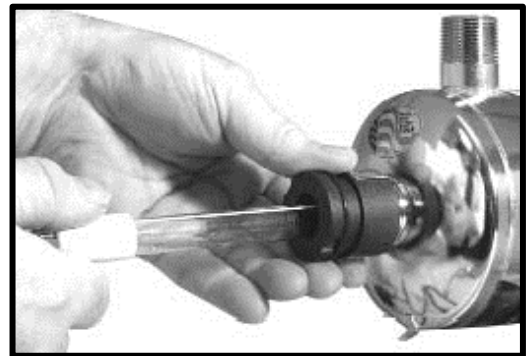
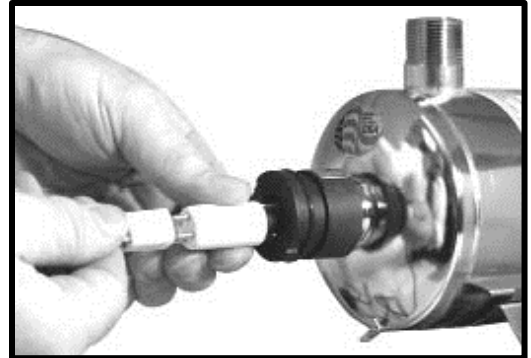
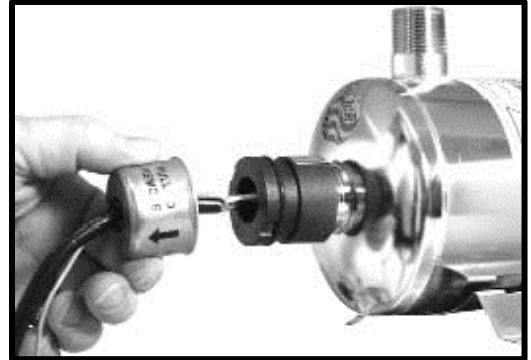

Figure 15. Removing UV lamp

 **WARNING: Germicidal ultraviolet rays are harmful to eyes and skin. Do not restore power to the Shield 1500 until the UVC lamp and easy-off end caps have been properly reinstalled.**

QUARTZ SLEEVE CLEANING OR REPLACEMENT

The Shield 1500 has been designed such that the UVC Lamp can be serviced without removing the sheet metal cover of the Shield 1500.

1. **Disconnect power to Shield 1500** and disconnect both the water input and output connections.
2. Follow the steps in “**UVC LAMP INSTALLATION OR REPLACEMENT**” to remove lamp. **CAUTION: Lamp and quartz sleeve are easily damaged. Exercise care when handling.**
3. Unscrew static gland nuts from each end of the chamber as shown in the top image of Figure 16. Avoid striking quartz sleeve with static gland nut.
4. Remove Teflon® washer and O-ring from both ends of quartz sleeve as shown in the middle image of Figure 16. Teflon® washer will sometimes remain within the static gland nut. If so, remove Teflon® washer from static gland nut before proceeding.
5. Carefully remove quartz sleeve from chamber as shown in the bottom image of Figure 16. **NOTE:** It is advisable to support the quartz sleeve on the backside with your finger so that it does not drop to the bottom of the chamber as it slides into the chamber.
6. Once the quartz sleeve is removed, clean with alcohol or a detergent. Stubborn stains usually can be removed with a dilute hydrochloric acid. **NOTE:** Follow all manufacturer's instructions and precautions when handling chemicals.
7. Reassemble in reverse order. Make sure the quartz sleeve protrudes an equal distance past each threaded nipple. Be sure O-rings are placed on quartz sleeve before Teflon® washer.

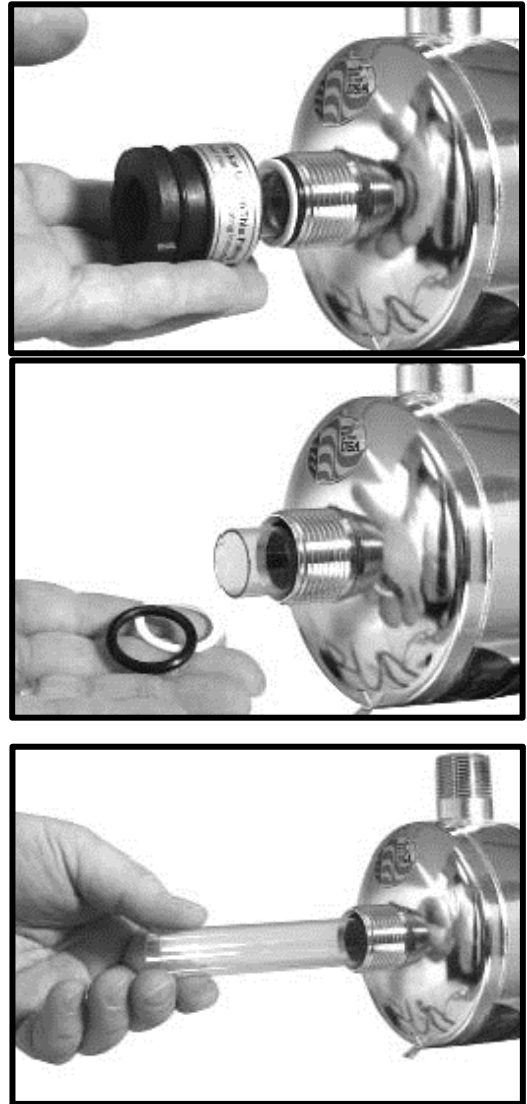

Figure 16. Replacing quartz sleeve

8. Tighten static gland nuts firmly by hand only, **DO NOT USE HAND TOOLS**. Tightening with hand tools is likely to cause quartz sleeve to break.
9. Reinstall lamp, following the steps in “**UVC LAMP INSTALLATION OR REPLACEMENT**” section.



WARNING: Germicidal ultraviolet rays are harmful to eyes and skin. Do not restore power to the Shield 1500 until the UVC lamp and easy-off end caps have been properly reinstalled.

Chapter 7: 20-inch NanoMesh Cartridge Maintenance

Introduction

The 20-inch NanoMesh Cartridge is designed to operate with a minimal amount of maintenance, providing the water quality meets input requirements (see **Facility Requirements** section).

Ordinary maintenance consists of;

- 20-inch NanoMesh Cartridge replacement – recommended after 10,000 hours of operation (approximately 60 weeks of continuous service) or when more than the top third of the cartridge becomes discolored—whichever happens first.
- Cleaning of the internal reflective surfaces with a clean dry cloth after canister replacement.

Always disconnect the water supply and completely drain the sump if it will be subjected to temperatures below the freezing point of water.

20-inch NanoMesh Cartridge Replacement

1. **Disconnect power to Shield 1500** and disconnect both the water input and output connections.
2. Depress the red pressure-relief button on the top of the unit to relieve the pressure inside the canister. Depress again as needed through Step 5.
3. Open the access door.
4. Pull the LED electrical lead socket connector straight down off the bottom of the sump.
5. Using the sump spanner wrench, twist off (moving wrench handle from right to left) the sump (for best results hold the wrench near the top of the sump and brace against the twisting by holding the inlet connection. Some water will spill in the process of removing the sump. **NOTE: Care should be taken in order to minimize water spills.** Set the sump on a flat surface. Be careful to not allow it to tip over. Dry up water from inside the Shield enclosure.
6. Remove the 20-inch NanoMesh Cartridge by pulling it straight up out of the sump.

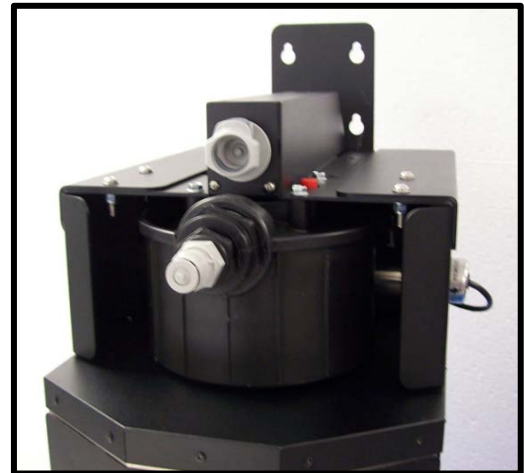

Figure 17. Depress red pressure-relief button

7. Ensure that the small black gasket at the top of the 20-inch NanoMesh Cartridge has also been removed from the Shield.
8. Dispose of the 20-inch NanoMesh Cartridge and its gasket in accordance with local and national regulations.
9. Wipe out the inside of the sump with a clean cloth to remove any residue. Ensure that all the following are wiped: walls of the sump, all 5 LED lenses at the bottom, disk holding the 5 LEDs.
10. Insert a new 20-inch NanoMesh Cartridge into the sump. Press it down firmly until it seats against the disk at the bottom.
11. Ensure that the black gasket is in the top of the Cartridge (U-shape facing downward like this: Π).
12. Screw the sump back into the cap and tighten with the spanner wrench until a hard stop (end of the threads) is felt.
13. Reconnect the water input and output connections allowing the sump to fill with water. Press the red pressure-relief button on the cap to release trapped air.
14. Check for leaks.
15. With a clean cloth wipe dry the interior reflective surfaces which may have been wet during the Pur-Cat Canister replacement.
16. Press the LED power lead sockets back onto their terminals in the bottom of the sump (socket diameter will now allow reversal of the leads).
17. Close access door.

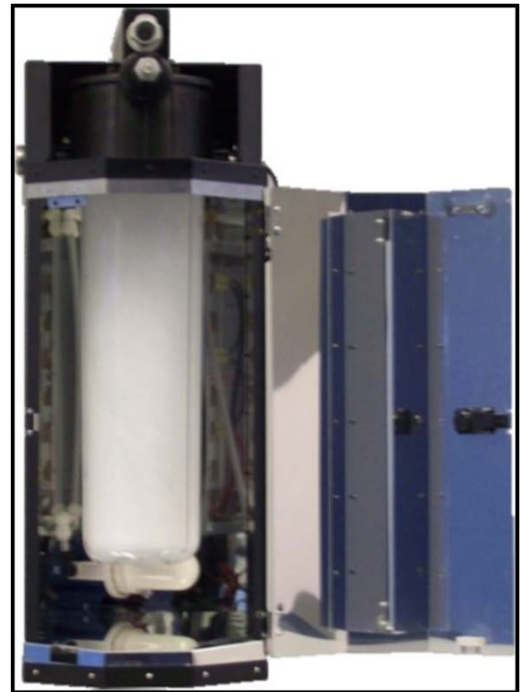



Figure 18. Interior reflective surfaces of the Shield 1500

 **WARNING: Do not restore power to the Shield 1500 until the sump and LED leads have been properly reinstalled.**

Chapter 8: Other Maintenance

Introduction

Beyond ordinary regular maintenance items, some additional maintenance may arise. If not found in this manual, contact Puralytics for additional assistance.

Power Input AC Fuse Replacement

1. **Disconnect power to Shield 1500.**
2. Locate the power input module (described above and shown in Figure 5). The AC fuse is the center piece located between the on/off switch and the power receptacle.
3. Use a flathead screwdriver to unclip the top bracket on the fuse holder (top image in Figure 19).
4. Use the same screwdriver to unclip the bottom bracket on the fuse holder (middle image in Figure 19) and pull the fuse towards you.
5. Grab the fuse holder with your fingers (bottom image in Figure 19) to remove it.
6. A burnt fuse will appear dark/discolored. Dispose of any burnt fuse.
7. A spare fuse is located in the fuse holder. Place it where the burnt fuse was located.
8. Push the fuse holder back into place.

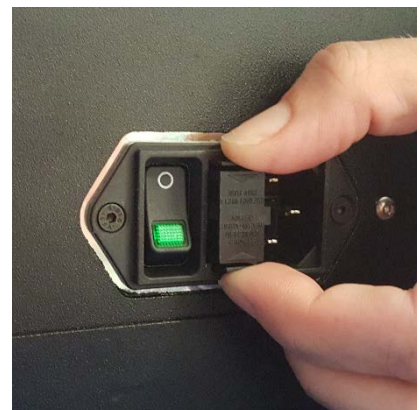

Figure 19. Images Depicting Fuse Replacement.